

Chopper IGBTMOD™ E-Series Module 50 Amperes/1200 Volts

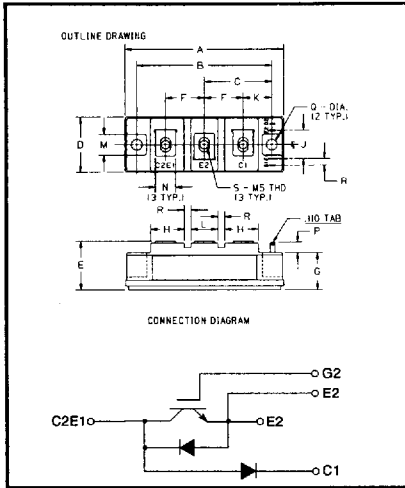

CM50E3Y-24E
Outline Drawing

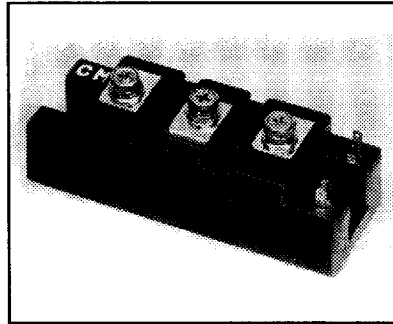

CM50E3Y-24E
Chopper IGBTMOD™ E-Series Module
50 Amperes/1200 Volts

Description:

Powerex Chopper IGBTMOD™ Modules are designed for use in switching applications. Each module consists of one IGBT Transistor having a reverse-connected super-fast recovery free-wheel diode and an anode-collector connected super-fast recovery free-wheel diode. All components and interconnects are isolated from the heat sinking baseplate, offering simplified system assembly and thermal management.

Features:

- Low Drive Power
- Low $V_{CE(sat)}$
- Discrete Super-Fast Recovery (150ns) Free-Wheel Diode
- High Frequency Operation (15-20kHz)
- Isolated Baseplate for Easy Heat Sinking

Applications:

- DC Motor Control
- Boost Regulator

Ordering Information:

Example: Select the complete part module number you desire from the table below

-i.e. CM50E3Y-24E is a 1200V (V_{CES}), 50 Ampere Chopper IGBTMOD™ Power Module.

Type	Current Rating Amperes	V_{CES} Volts (x 50)
CM	50	24

Dimensions	Inches	Millimeters
A	3.70	94.0
B	3.150±0.01	80.0±0.25
C	1.57	40.0
D	1.34	34.0
E	1.22 Max.	31.0 Max.
F	0.90	23.0
G	0.85	21.5
H	0.79	20.0
J	0.71	18.0
K	0.67	17.0
L	0.63	16.0
M	0.51	13.0
N	0.47	12.0
P	0.28	7.0
Q	0.265 Dia.	Dia. 6.5
R	0.16	4.0
S	M5 Metric	M5

WWW.IIIC.CC



Powerex, Inc., 200 Hillis Street, Youngwood, Pennsylvania 15697-1800 (412) 925-7272

CM50E3Y-24E
Chopper IGBTMOD™ E-Series Module
 50 Amperes/1200 Volts

Absolute Maximum Ratings, $T_J = 25\text{ }^\circ\text{C}$ unless otherwise specified

Ratings	Symbol	CM50E3Y-24E	Units
Junction Temperature	T_J	-40 to 150	$^\circ\text{C}$
Storage Temperature	T_{stg}	-40 to 125	$^\circ\text{C}$
Collector-Emitter Voltage (G-E SHORT)	V_{CES}	1200	Volts
Gate-Emitter Voltage	V_{GES}	± 20	Volts
Collector Current	I_C	50	Amperes
Peak Collector Current	I_{CM}	100*	Amperes
Diode Forward Current	I_{FM}	50	Amperes
Diode Forward Surge Current	I_{FM}	100*	Amperes
Power Dissipation	P_d	400	Watts
Max. Mounting Torque M5 Terminal Screws	-	17	in-lb
Max. Mounting Torque M6 Mounting Screws	-	26	in-lb
Module Weight (Typical)	-	190	Grams
V Isolation	V_{RMS}	2500	Volts

* Pulse width and repetition rate should be such that device junction temperature does not exceed the device rating.

Static Electrical Characteristics, $T_J = 25\text{ }^\circ\text{C}$ unless otherwise specified

Characteristics	Symbol	Test Conditions	Min.	Typ.	Max.	Units
Collector-Cutoff Current	I_{CES}	$V_{CE} = V_{CES}, V_{GE} = 0V$	-	-	1.0	mA
Gate Leakage Current	I_{GES}	$V_{GE} = V_{GES}, V_{CE} = 0V$	-	-	0.5	μA
Gate-Emitter Threshold Voltage	$V_{GE(th)}$	$I_C = 5\text{mA}, V_{CE} = 10V$	3.5	5.0	6.5	Volts
Collector-Emitter Saturation Voltage	$V_{CE(sat)}$	$I_C = 50\text{A}, V_{GE} = 15V$	-	-	4.0**	Volts
		$I_C = 50\text{A}, V_{GE} = 15V, T_J = 150^\circ\text{C}$	-	-	4.0**	Volts
Total Gate Charge	Q_G	$V_{CC} = 600V, I_C = 50\text{A}, V_{GS} = 15V$	-	530	-	nC
Diode Forward Voltage	V_{FM}	$I_E = 50\text{A}, V_{GE} = 0V$	-	-	2.5	Volts

** Pulse width and repetition rate should be such that device junction temperature rise is negligible.

Dynamic Electrical Characteristics, $T_J = 25\text{ }^\circ\text{C}$ unless otherwise specified

Characteristics	Symbol	Test Conditions	Min.	Typ.	Max.	Units
Input Capacitance	C_{ies}		-	-	20	nF
Output Capacitance	C_{oes}	$V_{GE} = 0V, V_{CE} = 10V, f = 1\text{MHz}$	-	-	6	nF
Reverse Transfer Capacitance	C_{res}		-	-	4	nF
Resistive	Turn-on Delay Time	$V_{CC} = 600V, I_C = 50\text{A}, V_{GE1} = V_{GE2} = 15V, R_G = 6.3\Omega$	-	-	100	ns
Load	Rise Time		-	-	200	ns
Switch Times	Turn-off Delay Time		-	-	200	ns
	Fall Time		-	-	400	ns
Diode Reverse Recovery Time	t_{rr}	$I_E = 50\text{A}, di_E/dt = -100\text{A}/\mu\text{s}$	-	-	300	ns
Diode Reverse Recovery Charge	Q_{rr}	$I_E = 50\text{A}, di_E/dt = -100\text{A}/\mu\text{s}$	-	1.1	-	μC

Thermal and Mechanical Characteristics, $T_J = 25\text{ }^\circ\text{C}$ unless otherwise specified

Characteristics	Symbol	Test Conditions	Min.	Typ.	Max.	Units
Thermal Resistance, Junction to Case	$R_{th(j-c)}$	Per IGBT	-	-	0.31	$^\circ\text{C}/\text{W}$
Thermal Resistance, Junction to Case	$R_{th(j-c)}$	Per Free Wheel Diode	-	-	0.70	$^\circ\text{C}/\text{W}$
Contact Thermal Resistance	$R_{th(c-f)}$	Per Half Module	-	-	0.15	$^\circ\text{C}/\text{W}$



Powerex, Inc., 200 Hillis Street, Youngwood, Pennsylvania 15697-1800 (412) 925-7272

CM50E3Y-24E
Chopper IGBTMOD™ E-Series Module
 50 Amperes/1200 Volts

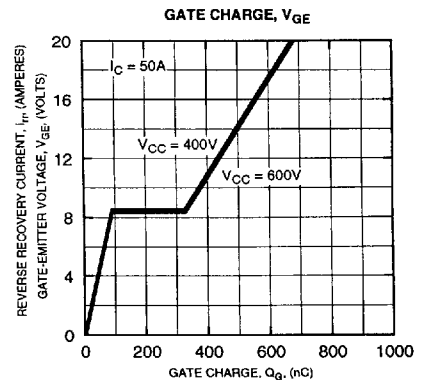
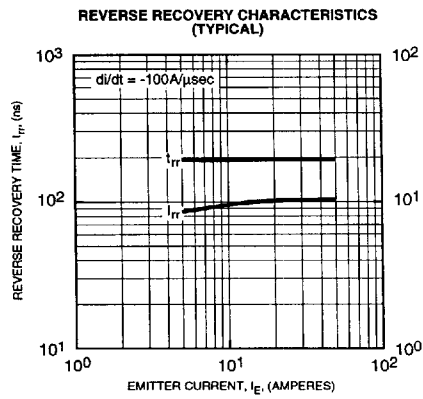
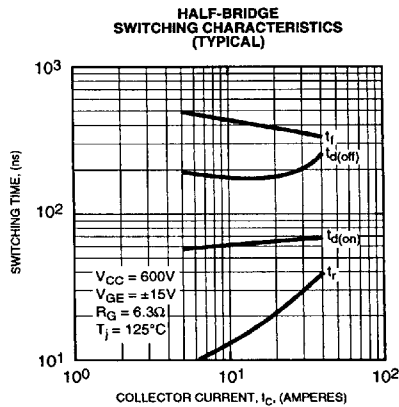
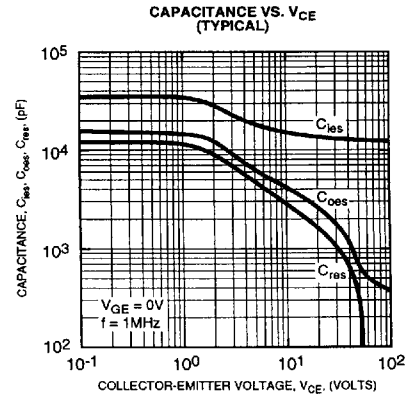
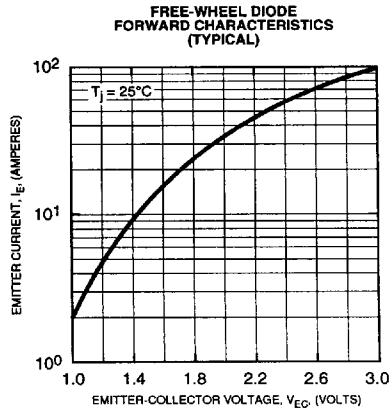
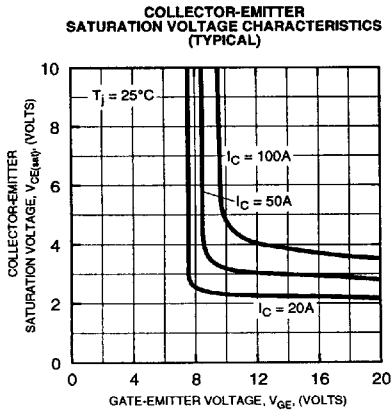
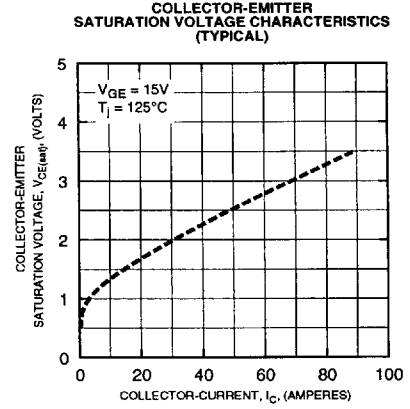
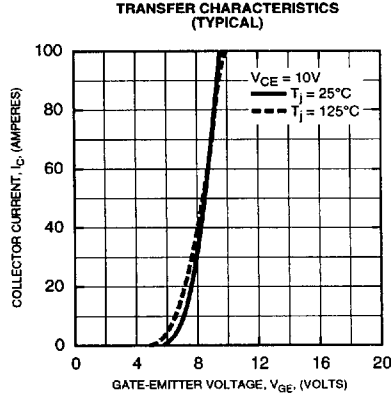
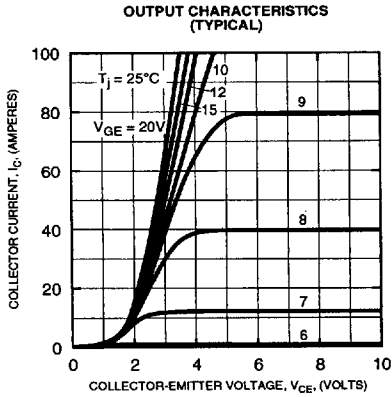

7294621 0007265 451

CM50E3Y-24E
Chopper IGBTMOD™ E-Series Module
 50 Amperes/1200 Volts

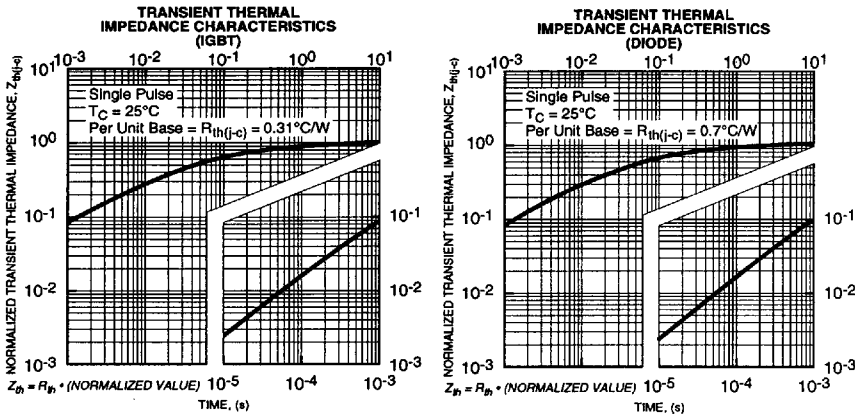

SWITCHING TIME TEST CIRCUITS & WAVEFORMS

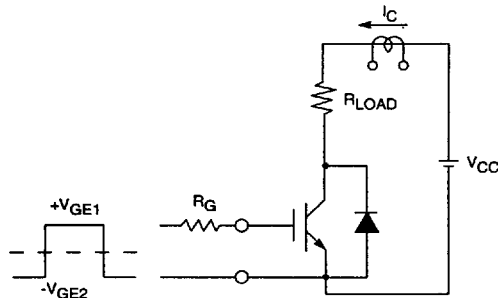

RESISTANCE LOAD SWITCHING TEST CIRCUIT

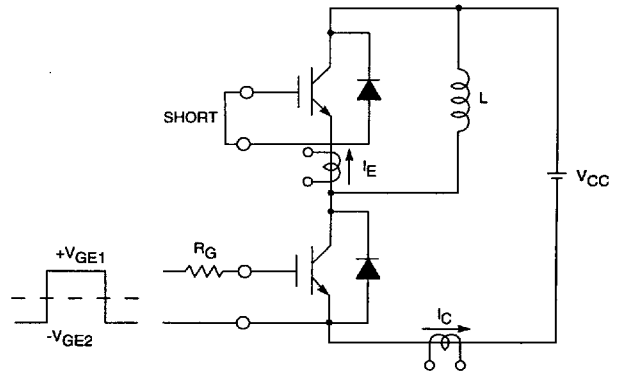

HALF-BRIDGE SWITCHING TEST CIRCUIT

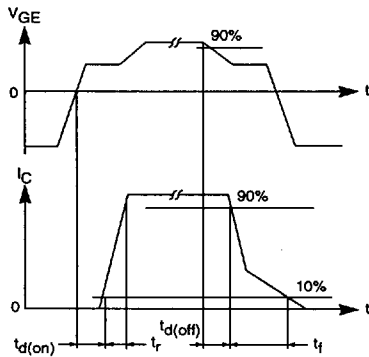

SWITCHING TIME TEST WAVEFORMS

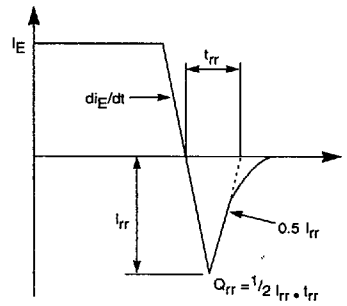

t_{rr}, Q_{rr} WAVEFORMS