

THYRISTOR

100A Avg 1600 Volts

PDT10016
PDH10016
PCH10016

■回路図 CIRCUIT

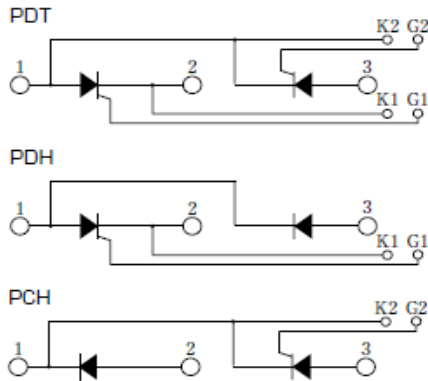

■外形寸法図 OUTLINE DRAWING

Dimension: [mm]

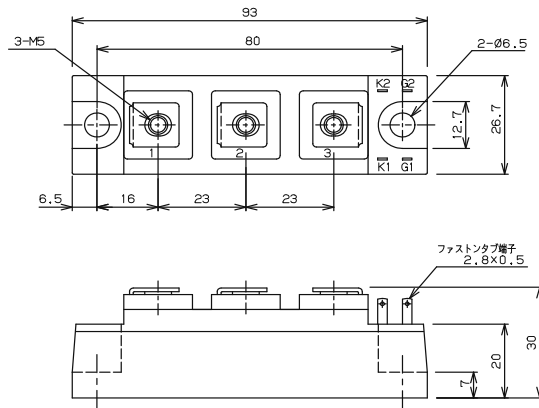

■最大定格 Maximum Ratings

項目 Parameter	記号 Symbol	耐圧クラス Grade		単位 Unit
		PDT10016/PDH10016/PCH10016		
くり返しピークオフ電圧 Repetitive Peak Off-State Voltage	V_{DRM}	1600		V
非くり返しピークオフ電圧 Non Repetitive Peak Off-State Voltage	V_{DSM}	1700		V
くり返しピーク逆電圧 Repetitive Peak Reverse Voltage	V_{RRM}	1600		V
非くり返しピーク逆電圧 Non Repetitive Peak Reverse Voltage	V_{RSM}	1700		V

項目 Parameter	記号 Symbol	条件 Conditions	定格値 Max. Rated Value	単位 Unit		
平均オン電流 Average On-State Current	$I_{O(AV)}$	商用周波数 180° 通電 $T_c=77^\circ\text{C}$ Half Sine Wave	100	A		
実効オン電流 RMS On-State Current	I_{TRMS}		156	A		
サージオン電流 Surge On-State Current	I_{ISM}	50Hz 正弦半波, 1サージ, 非くり返し Half Sine Wave, 1Pulse, Non-Repetitive	2000	A		
電流二乗時間積 I Squared t	I^2t	2~10ms	20000	$\text{A}^2 \text{s}$		
臨界オン電流上昇率 Critical Rate of Rise of Turned-On Current	di/dt	$V_D=2/3 V_{DRM}$, $I_{TM}=2 \cdot I_O$, $T_J=125^\circ\text{C}$ $I_G=200\text{mA}$, $di/dt=0.2\text{A}/\mu\text{s}$	100	$\text{A}/\mu\text{s}$		
ピークゲート電力損失 Peak Gate Power	P_{GM}		5	W		
平均ゲート電力損失 Average Gate Power	$P_{G(AV)}$		1	W		
ピークゲート電流 Peak Gate Current	I_{GM}		2	A		
ピークゲート電圧 Peak Gate Voltage	V_{GM}		10	V		
ピークゲート逆電圧 Peak Gate Reverse Voltage	V_{RGM}		5	V		
動作接合温度範囲 Operating Junction Temperature Range	T_{JW}		-40 ~ +125	$^\circ\text{C}$		
保存温度範囲 Storage Temperature Range	T_{stg}		-40 ~ +125	$^\circ\text{C}$		
絶縁耐圧 Isolation Voltage	V_{iso}	端子-ベース間, AC 1分間 Terminal to Base, AC 1min.	2500	V		
締付トルク Mounting Torque	ベース部 Mounting	F	サマルコパッド [®] 塗布 Greased	M6	2.4 ~ 3.5	$\text{N} \cdot \text{m}$
	主端子部 Terminal			M5	2.4 ~ 2.8	$\text{N} \cdot \text{m}$

■電気的特性 Electrical Characteristics

項目 Parameter	記号 Symbol	条件 Conditions	特性値 (最大) Maximum Value			単位 Unit
			最小 Min.	標準 Typ.	最大 Max.	
ピークオフ電流 Peak Off-State Current	I_{DM}	$T_j=125^\circ\text{C}$, $V_{DM}=V_{DRM}$			20	mA
ピーク逆電流 Peak Reverse Current	I_{RM}	$T_j=125^\circ\text{C}$, $V_{RM}=V_{RRM}$			20	mA
ピークオン電圧 Peak On-State Voltage	V_{TM}	$T_j=25^\circ\text{C}$, $I_{TM}=300\text{A}$			1.38	V
トリガゲート電流 Gate Current to Trigger	I_{GT}	$V_D=6\text{V}$, $I_T=1\text{A}$	$T_j=-40^\circ\text{C}$		200	mA
			$T_j=25^\circ\text{C}$		100	mA
			$T_j=125^\circ\text{C}$		50	mA
			$T_j=-40^\circ\text{C}$		4	V
トリガゲート電圧 Gate Voltage to Trigger	V_{GT}	$V_D=6\text{V}$, $I_T=1\text{A}$	$T_j=-40^\circ\text{C}$		4	V
			$T_j=25^\circ\text{C}$		2.5	V
			$T_j=125^\circ\text{C}$		2	V
			$T_j=125^\circ\text{C}$		2	V
非トリガゲート電圧 Gate Non-Trigger Voltage	V_{GD}	$T_j=125^\circ\text{C}$, $V_D=2/3V_{DRM}$	0.25			V
臨界オフ電圧上昇率 Critical Rate of Rise of Off-State Voltage	dv/dt	$T_j=125^\circ\text{C}$, $V_D=2/3V_{DRM}$	500			V/ μs
ターンオフ時間 Turn-Off Time	t_q	$T_j=125^\circ\text{C}$, $I_{TM}=I_o$, $V_D=2/3V_{DRM}$ $dv/dt=20\text{V}/\mu\text{s}$, $V_R=100\text{V}$, $-di/dt=20\text{A}/\mu\text{s}$		100		μs
ターンオン時間 Turn-On Time	t_{gt}			6		μs
遅れ時間 Delay Time	t_d	$T_j=25^\circ\text{C}$, $V_D=2/3V_{DRM}$ $I_G=200\text{mA}$, $di_g/dt=0.2\text{A}/\mu\text{s}$		2		μs
立上がり時間 Rise Time	t_r			4		μs
ラッチング電流 Latching Current	I_L	$T_j=25^\circ\text{C}$		100		mA
保持電流 Holding Current	I_H	$T_j=25^\circ\text{C}$		50		mA
熱抵抗 Thermal Resistance	$R_{th(j-c)}$	接合部-ケース間 Junction to Case			0.35	$^\circ\text{C}/\text{W}$
接触熱抵抗 Thermal Resistance	$R_{th(c-f)}$	ケース-フィン間, サーマルコンパウンド塗布 Case to Fin, Greased			0.2	$^\circ\text{C}/\text{W}$

質量…約155g
Approximate Weight

1アーム当りの値 Value Per 1 Arm.

■定格・特性曲線

オン電圧特性
ON-STATE CURRENT VS. VOLTAGE

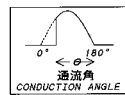
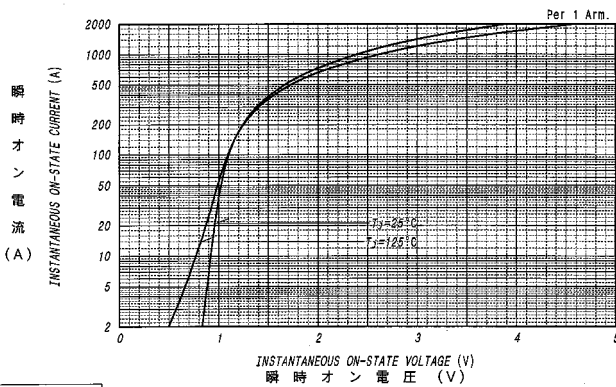

平均オン電力損失特性
AVERAGE ON-STATE POWER DISSIPATION
for SINUSOIDAL CURRENT WAVEFORM

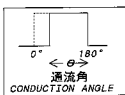
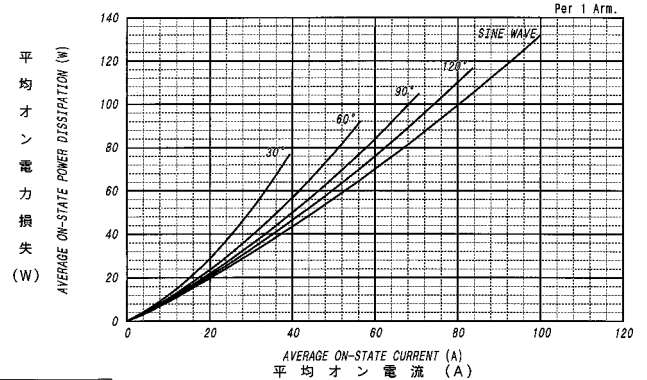

平均オン電力損失特性
AVERAGE ON-STATE POWER DISSIPATION
for RECTANGULAR CURRENT WAVEFORM

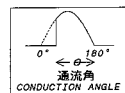
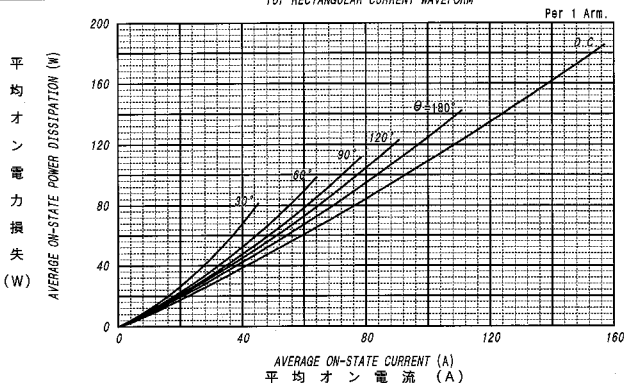

平均オン電流-ケース温度定格
AVERAGE ON-STATE CURRENT VS. CASE TEMPERATURE

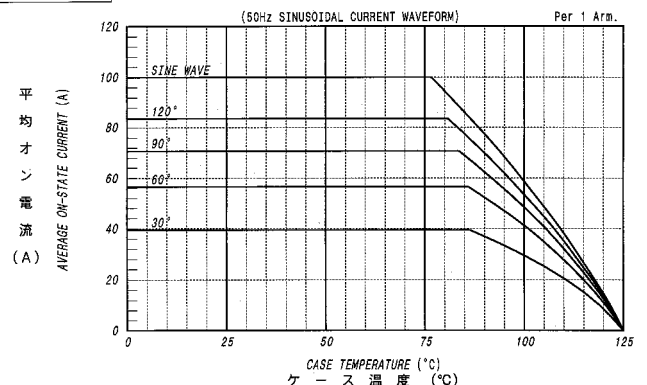

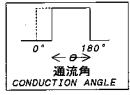

平均オン電流 - ケース温度定格
AVERAGE ON-STATE CURRENT VS. CASE TEMPERATURE

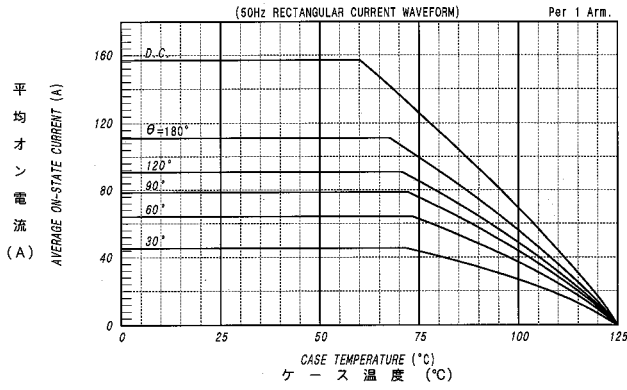

ゲート特性
GATE CHARACTERISTICS

サージオン電流定格
SURGE CURRENT RATINGS

f=50Hz, Half Sine Wave, Non-Repetitive, T_j=125°C

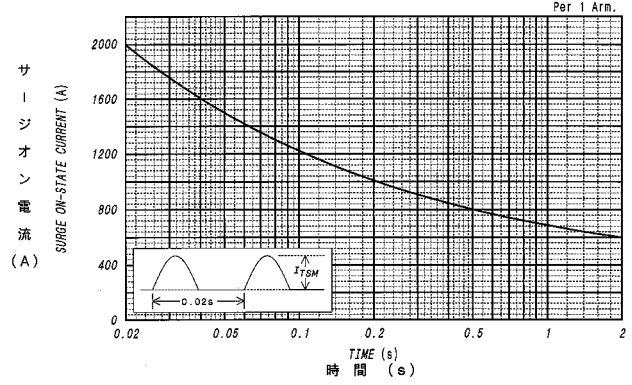

ゲート定格
GATE RATINGS

トリガゲート電圧 (V)

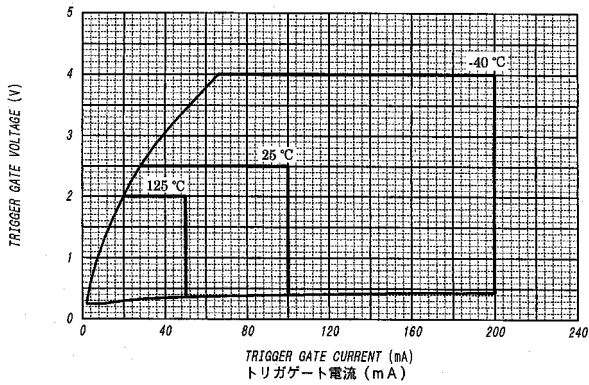

過渡熱抵抗特性
MAXIMUM TRANSIENT THERMAL IMPEDANCE
Junction to Case

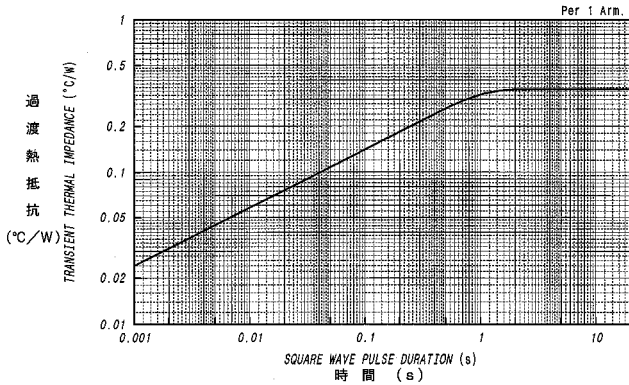

ゲート電圧 (V)

